

Assembly instructions
PURE SOFA meridienne left/right
01203 / 01204 / 012303-03 / 01204-03

Tribù nv
Langendijkstraat 5a
3690 Zutendaal
BELGIUM

www.tribu.com
info@tribu.com

TRIBÙ
The art of leisure

Content

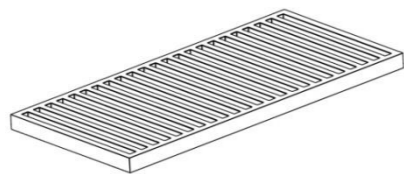
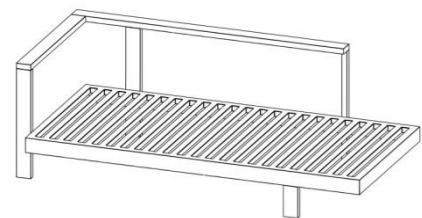

1 x seatrest

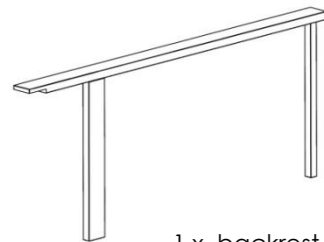

1 x backrest



3 x M6x2,5cm



1 x seat support



10 x M6x5,0cm

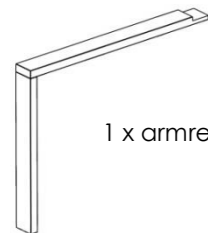

1 x armrest

woodglue



1 x leg

Assembly Instructions

1 Put glue on the thin part of the armrest and on the thin part of the backrest.

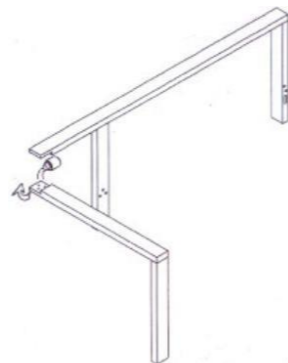

2 Carefully connect the armrest to the backrest using the three M6x2,5cm bolts. Tighten the bolts well, using the M6 Allen key (not included). Clean the outcoming glue.

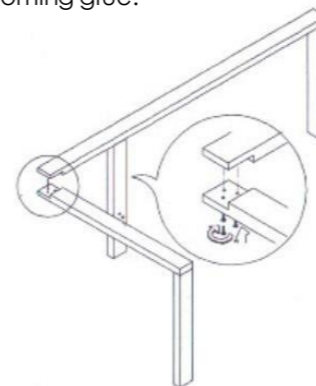

3 Put glue on the tenon and hole. Insert the tenon in the hole. Clean the outcoming glue.

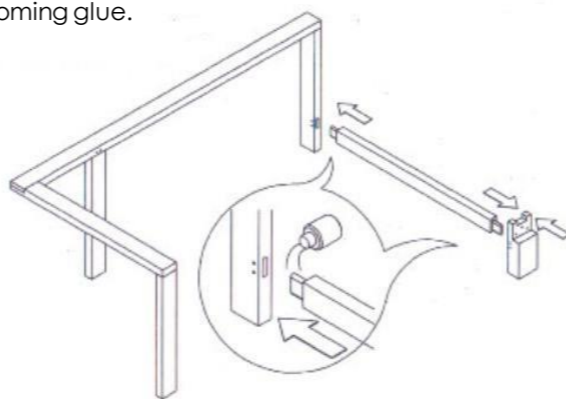

4 Now gently tilt the sofa right on its side. Put glue on the thin part of the mini frontleg. Clean the outcoming glue.

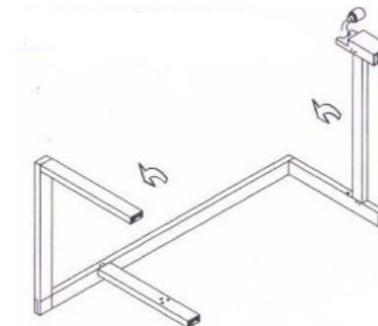

5 Insert the seatrest between the backrest and armrest.

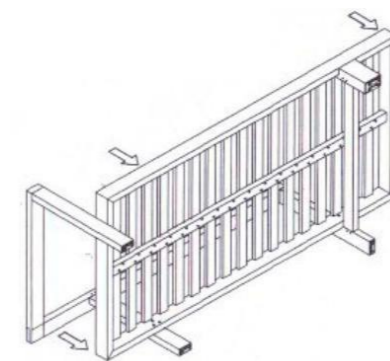

6 Use 2 M6x5,0 cm to fix the seat with the frontleg (A). Repeat this step for the other legs (B & C).

