

Assembly instructions

**Tosca Dining Tables
Tosca Low Dining Tables**

05355 - 05354

05335 - 05334

Tribù nv
Oude Heidestraat 72
3740 Bilzen
BELGIUM

www.tribu.com
info@tribu.com

TRIBÙ

CONTENT

05354 Table
05334 Table



1x Table top

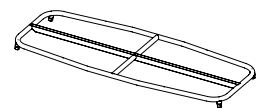

1x Frame



4 x
Leg

05355 Table
05335 Table

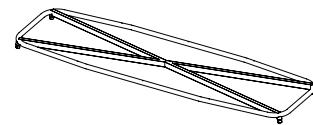
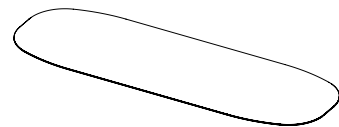

11 x
Suction Cup

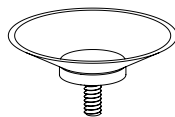

ASSEMBLY INSTRUCTIONS

- 1 Open the box of the table top. Degrease the glass with tribù Glass & Ceramic Cleaner (D9938) and wipe the surface until it is dry. Leave the table top in the box.
- 2 Open the box of the frame, make sure it's upside down. Then attach the legs to the frame.

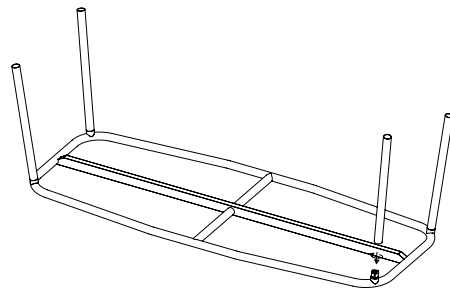

- 3 Turn the frame with the legs upside down. Fasten the suction cups onto the frame as shown in the picture below. The frame has holes in which you can fasten the threaded suction cup.

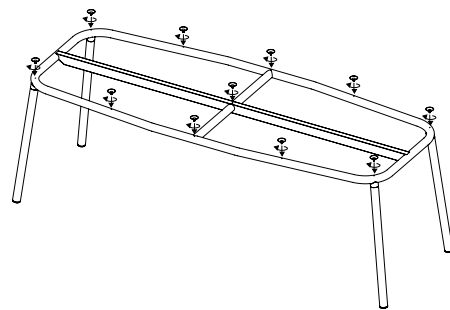

- 4 Put the table frame upside down onto the table top. The table top is marked where the suction cups should be positioned.

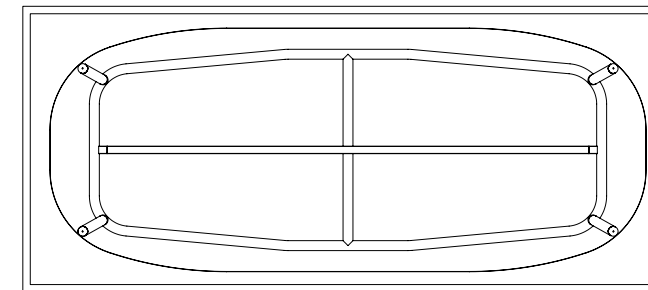

- 5 When taking the table out of the box, please hold the frame and the table top.